

S9878

Simplicity[®]



Designed and printed in USA.

easy-to-sew

Shop all the pattern brands you love @

Simplicity[®].com

Easy

KITCHEN ACCESSORIES

Suggested Fabrics: Chintz, Cotton Types, Gingham, Linen Types. **C,D** also in Laminates.
Interfacing A,C: Lightweight Fusible. **Batting B,E:** Heat Resistant Batting, Lightweight Cotton Batting. **Interfacing D:** Fusible Fleece.

Notions: **A:** One 20" x 30" (51cm x 76cm) dish towel, one pkg. of ½" (1.3cm) double fold bias tape, one 1" (2.5cm) pom pom, one ½" (1.3cm) magnetic snap, two novelty buttons, ¼ yd. (0.8m) of mini rick rack or mini puff ball trim. **B:** One pkg. of ½" (1.3cm) double fold bias tape, ¾ yd. (0.3m) of ¾" (1cm) grosgrain ribbon. **C:** Polyfiberfill, rice or plastic pellets. **D:** Rice or plastic pellets. **E:** One pkg. of ½" (1.3cm) double fold bias tape, 1¼ yds. (1.1m) of mini rick rack trim.

Dish Towel A - 11" tall, 6½" diameter at base (without towel) (28cm x 16cm)

45"* - ½ yd. (115cm* - 0.5m)
Interfacing: 7" x 2" (18cm x 5cm) remnant

Pot holders B (Makes 2) - 4" tall, 3½" diameter at base each (10cm x 9cm)

19" x 9" (48cm x 23cm) fabric remnant
Batting: 10" x 9" (25cm x 23cm) remnant

Phone Stand C - 7" tall, 7" wide at base (18cm x 18cm)

15" x 11" (38cm x 28cm) each of fabric and interfacing remnants
Lining: 15" x 9" (38cm x 23cm) remnant

Book Weight D - 12" long, 1½" wide at center (30cm x 4cm)

26" x 3" (66cm x 8cm) fabric remnant
Interfacing: 13" x 3" (33cm x 8cm) remnant

Trivet E - 14" x 14" (36cm x 36cm)

45"* - ½ yd. (115cm* - 0.5m)
Mushroom Lower Cap and Stem Applique: 8" x 9" (21cm x 23cm) fabric remnant
Mushroom Upper Cap Applique: 7" (18cm) square fabric remnant
Batting: 15" x 15" (38cm x 38cm) remnant
Paper-backed fusible web: 17" - ¾ yd. (43cm - 0.4m)

*with nap **without nap



A



B



C



D

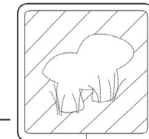

E

Simplicity® S9878

Thank you for purchasing this Simplicity pattern.
We made every effort to provide you with a high quality product.

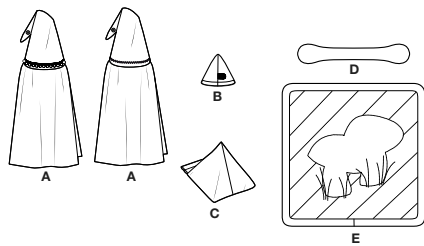
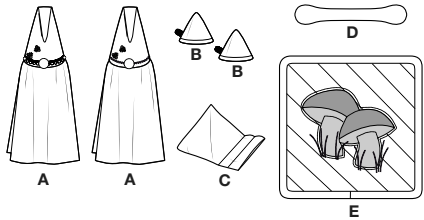

9 PIECES

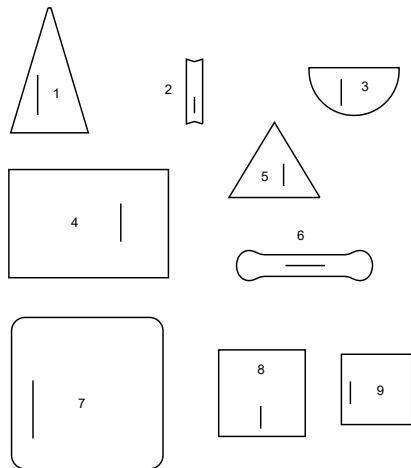

- 1 TOWEL HANGER - A
- 2 STRAP - A
- 3 POT HOLDER - B
- 4 PHONE STAND - C
- 5 PELLET BAG - C
- 6 BOOK WEIGHT - D
- 7 HOTPAD FRONT AND BACK - E
- 8 MUSHROOM LOWER CAP AND STEM APPLIQUES - E
- 9 MUSHROOM UPPER CAP APPLIQUES - E

Cutting Layouts

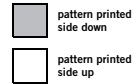

POSITION OF PATTERN PIECES MAY VARY
SLIGHTLY ACCORDING TO YOUR PATTERN SIZE

General Directions For Cutting

PRE-SHRINK and iron all fabric.
FOR DOUBLE THICKNESS -Fold fabric with RIGHT sides together.
Pin pattern to WRONG side of fabric.

FOR SINGLE THICKNESS -Pin pattern to RIGHT side of fabric.

★ If layout shows a piece extending past fold, cut out all pieces except piece that extends. Open out fabric to single thickness. Cut extending piece on RIGHT side of fabric in position shown.

✱ Mark small arrows along both selvages in dictating direction of nap or design. Fold fabric crosswise with RIGHT sides together, and cut along fold. Turn one fabric layer around so arrows on both layers go in the same direction. Place RIGHT sides together.

DISH TOWEL A

USE PIECES 1 2

45" (115CM)
WITH NAP

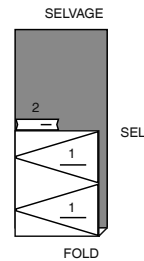

INTERFACING

CUT ONE OF PIECE 2 FROM INTERFACING REMNANT

POT HOLDER B

CUT FOUR OF PIECE 3 FROM FABRIC REMNANT

BATTING

CUT TWO OF PIECE 3 FROM BATTING REMNANT

PHONE STAND C

CUT ONE OF PIECE 4 FROM FABRIC AND INTERFACING REMNANTS

LINING

CUT TWO OF PIECE 5 FROM FABRIC REMNANT

BOOK WEIGHT D

CUT TWO OF PIECE 6 FROM FABRIC REMNANT

INTERFACING

CUT ONE OF PIECE 6 FROM FUSIBLE FLEECE REMNANT

TRIVET E

USE PIECE 7

45" (115CM)
WITH NAP

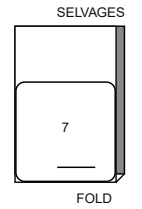

BATTING

CUT ONE OF PIECE 7 FROM BATTING REMNANT

MUSHROOM LOWER CAP AND STEM APPLIQUE

CUT ONE OF PIECE 8 FROM FABRIC REMNANT

MUSHROOM UPPER CAP APPLIQUE

CUT ONE OF PIECE 9 FROM FABRIC REMNANT

PAPER BACKED FUSIBLE WEB

USE PIECES 8 9

17" (43CM)

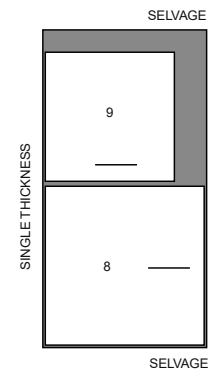

Sewing Directions

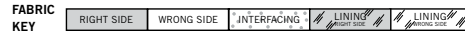

Read **General Directions** on page 1 before you begin.

GENERAL DIRECTIONS FOR APPLYING DOUBLE FOLD BIAS TAPE

Double fold bias tape comes with one side slightly wider than the other. The wider side is used on the **INSIDE** so that when the tape is stitched in place from the **OUTSIDE**, both edges are caught in the stitching.

Curves:

If tape is applied to a curved surface, first, pre-shape it with a steam iron.

For an inward curve, stretch the double edges and press; for an outward curve, stretch the fold edge and press.

TIP FOR SHAPING TRIM- Place trim along the pattern tissue and then follow instructions above.

Corners:

Encase one edge all the way to raw edge of fabric. Raise presser foot and cut the thread.

Turn tape around corner and pin in place.

Fold tape diagonally on both sides of corner; lower needle into diagonal fold and stitch the remaining side.

Ends:

Turn tape ends under to finish an edge or enclose at the seam when possible.

When tape completely encloses an edge, arrange to have ends meet at a seam if possible; then turn both ends under where they meet and tack together invisibly after stitching on tape.

OR

Have one end extend 1/2" (1.3cm) beyond the seam; then turn under and lap remaining end at the seam.

Sewing methods in **BOLD TYPE** have Sewing Tutorial Video available. Scan QR CODE to watch videos:

REINFORCE - see **Machine Stitches: "how to reinforce"** video.

SLIPSTITCH - see **Hand Stitching: "how to slipstitch"** video.

PATTERN PIECES WILL BE IDENTIFIED BY NUMBERS THE FIRST TIME THEY ARE USED.

STITCH SEAMS WITH RIGHT SIDES TOGETHER IN 1/4" (6MM) SEAMS UNLESS OTHERWISE STATED.

GNOME DISH TOWEL HOLDER A

1. Make two towels as follows:
Apply fusible interfacing to **WRONG** side of two towel hanger (1) sections, following manufacturer's directions.
Stitch sections together at sides, pivoting with needle in fabric at point.
REINFORCE seam at point.
Trim corners.
This is the towel; the remaining sections will be used for the towel lining.

2. Turn towel **RIGHT** side out; press.

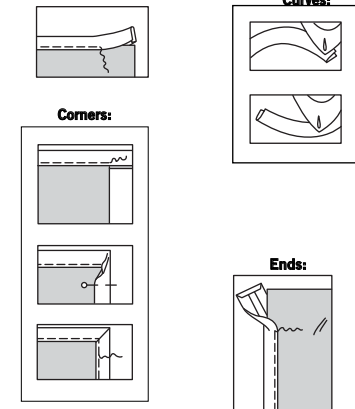

SEWING TUTORIALS



Build your skills viewing short, easy-to-follow videos at simplicity.com/sewingtutorials

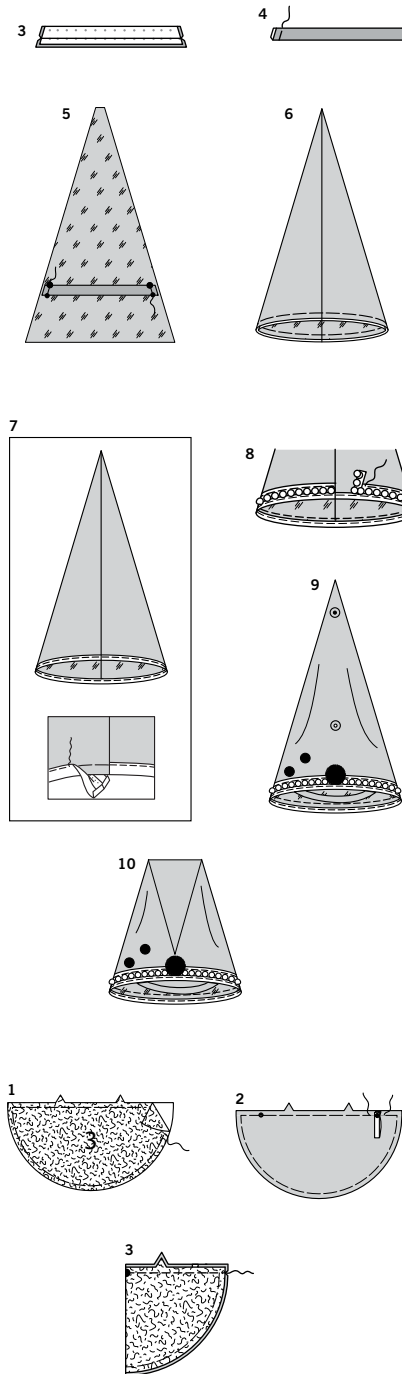
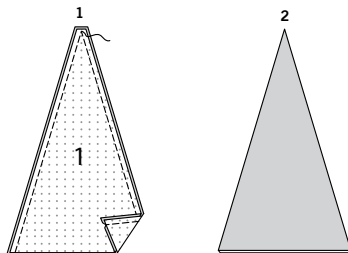

3. Apply interfacing to **WRONG** side of strap (2).
Fold strap in half, lengthwise, with **RIGHT** sides together.
Stitch, leaving ends open.

4. Turn strap; press.
Baste raw edges together.

5. Baste strap to **RIGHT** side of one towel lining section, matching small and large dots.

6. Stitch towel lining sections together same as for towel.
Insert lining into towel, having **WRONG** sides together, matching seams and having raw edges even. Baste 1/4" (6mm) from raw edges.

7. Slip raw edges of towel holder between folds of double fold bias tape, placing raw edges against center crease and the folded edge of the tape on **INSIDE**, turning under ends at one seam or at center of back.
Stitch tape in place from **OUTSIDE**, being sure to catch in folded edge on the **INSIDE**. See **GENERAL DIRECTIONS FOR DOUBLE FOLD BIAS TAPE**.

8. On **OUTSIDE**, center and pin puffball trim or rick rack over tape stitching, turning under ends at one side seam or at center of back. Stitch along center of trim.

9. Hand-sew pom pom to lower edge of front at center small dot.
Apply magnetic snap to remaining small dots along center, having knob half at the top small dot and socket half at lower small dot, following manufacturer's directions.
Sew buttons at small dots near side seam.

10. Fasten snap.
When using holder, insert purchased towel over strap.

POT HOLDER B

1. For each pot holder, pin heat protective batting to **WRONG** side of one pot holder (3) section.
Baste a scant 1/4" (6mm) from raw edges.

2. Cut one piece of ribbon, 4" (10cm) long.
Fold ribbon in half, having ends and edges even.
Baste to **RIGHT** side of pot holder over one small dot, having raw edges even.

3. Fold pot holder in half at large dot, matching notches.
Stitch notched edge.
This is your pot holder. The remaining pot holder sections will be used for the pot holder lining.

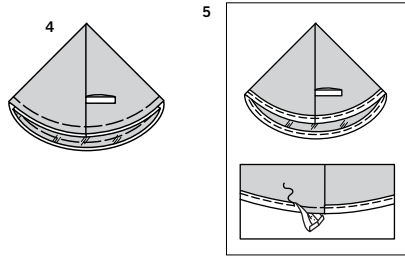

4. Stitch pot holder lining same as for pot holder, omitting ribbon. Insert lining into pot holder, having WRONG sides together, matching seams and having raw edges even. Baste raw edges together 1/4" (6mm) from raw edges.
5. Slip raw edges of pot holder between folds of double fold bias tape, placing raw edges against center crease and wider folded edge of tape on INSIDE, turning under ends at seam. Stitch tape in place from OUTSIDE, being sure to catch in folded edge on the INSIDE. See **GENERAL DIRECTIONS FOR DOUBLE FOLD BIAS TAPE**.

PHONE STAND C

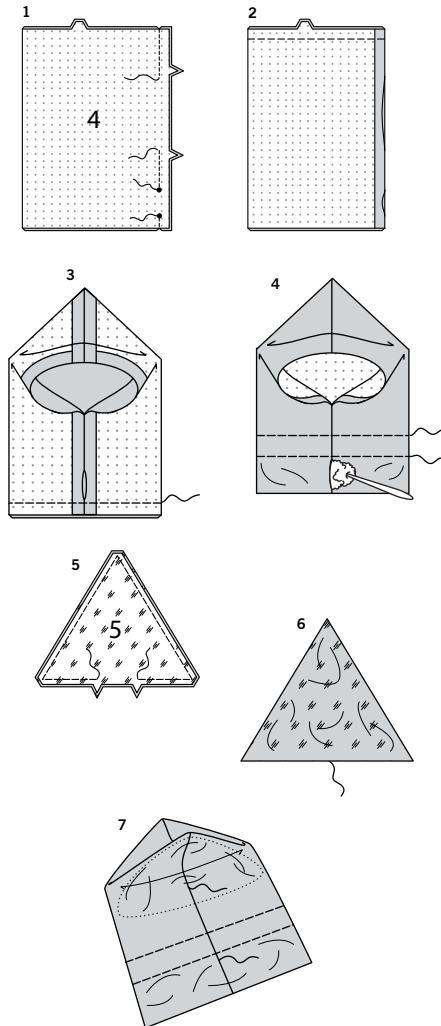

1. Apply fusible interfacing to WRONG side of phone stand (4), following manufacturer's directions. With RIGHT sides together and raw edges even, fold stand along center foldline, matching single and double notches, at shown. Stitch single-notched edge in a 1/2" (1.3cm) seam, leaving seam open between notches and between small dots, as shown; back-stitch at each end of opening to reinforce seam. Press seam open, pressing under seam allowance on opening edge.
2. Fold stand along center foldline, matching double notches. Stitch double-notched edge in a 1/2" (1.3cm) seam.
3. Fold stand along remaining foldlines, centering seam between folds, having raw edges even. Stitch raw edges together in a 1/2" (1.3cm) seam.
4. Turn stand RIGHT side out, folding at small dots on foldlines. Press side foldlines.
FOR FIBERFILL - Pull fiberfill apart and fluff it before you use it. Break apart lumps and thick spots. Using small pieces, pack fiberfill into small opening, packing firmly each time stuffing is added. Use both hands to mold and shape, being careful not to over stuff or make lopsided.
FOR RICE OR PELLETS - Fill lower edge of stand to lower stitching line, using enough pellets to be able to support the phone.
FOR FIBERFILL, RICE OR PELLETS - Stitch along both stitching lines, using a zipper foot to stitch along lower stitching line if necessary.
5. Pin pellet bag (5) sections together along outer edges, matching notches and having raw edges even. Stitch outer edges, leaving seam open between notches on one side; backstitch at notches to reinforce seam. **REINFORCE** seam along corners. Trim corners.
6. Turn bag RIGHT side out.
FOR FIBERFILL - Pull fiberfill apart and fluff it before you use it. Break apart lumps and thick spots. Using pieces about the size of a tennis ball or smaller, pack fiberfill into bag using the end of a long handled wooden spoon or chopstick. Pack firmly in place each time stuffing is added. Use both hands to mold and shape, being careful not to over stuff or make lopsided.
FOR RICE OR PELLETS - Fill bag with enough pellets to be able to support the phone,
FOR FIBERFILL, RICE, OR PELLETS - **SLIPSTITCH** opening closed.
7. Slip bag into large opening in stand. **SLIPSTITCH** openings closed. Mold stand around bag.

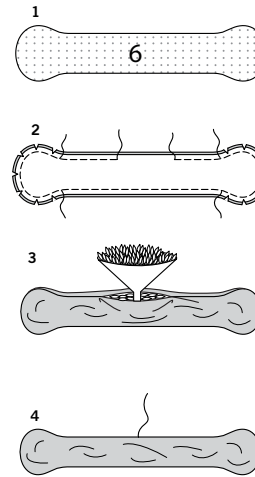

BOOK WEIGHT D

1. Apply fusible fleece to WRONG side of one book weight (6) section, following manufacturer's directions.
2. Pin book weight sections together along outer edges, having raw edges even. Stitch along outer edges, leaving an opening in one long edge for turning. Backstitch at ends of opening to reinforce seam. **REINFORCE** seam along curves. Clip curves.
3. Turn book weight RIGHT side out. Press. Fill bag with enough pellets or rice to be able to hold book open.
4. **SLIPSTITCH** opening closed.

TRIVET E

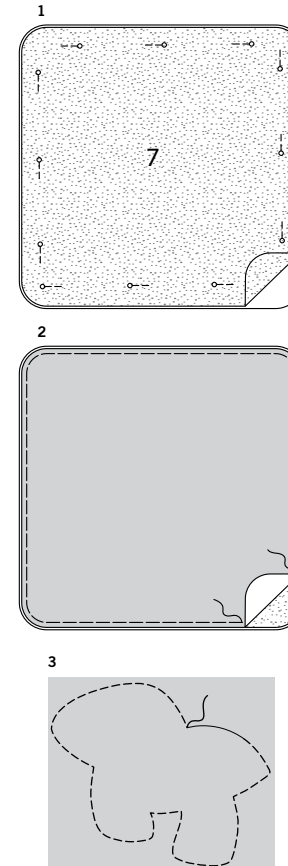

1. Pin heat protective batting to WRONG side of one hot pad front and back (7) section.
2. With WRONG sides together, pin hot pad front and back sections together, sandwiching batting, having raw edges even. Baste 1/4" (6mm) from raw edges.
3. Quilt hot pad, as follows: Machine-stitch along stitching lines surrounding group of appliques.

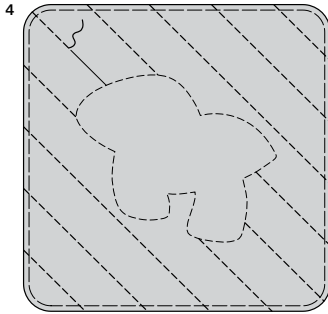

4. Machine-stitch along straight stitching lines as far as stitching surrounding appliques.

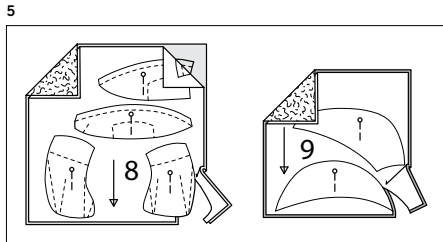

5. Apply paper backed fusible web to **WRONG** side of applique fabric for mushroom lower cap, and stem appliques (8) and mushroom upper cap applique (9), following manufacturer's directions. Cut each applique tissue block along outer solid line. Pin pattern to **RIGHT** side of prepared fabric. Cut out each applique. Transfer markings to **RIGHT** side of applique using a washable fabric marking pen or pencil.

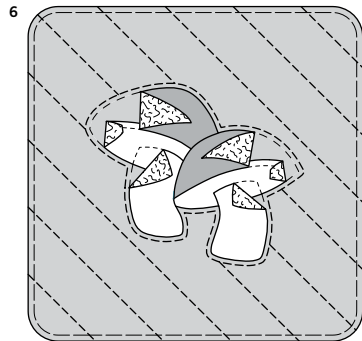

6. Layer appliques on top of hot pad, having outer edges along broken lines, lapping upper caps and stems over lower caps, as shown. Fuse in place, following manufacturer's directions.

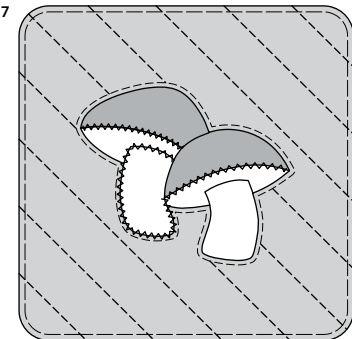

7. Stitch appliques in the following order:
Zigzag over lower raw edges of left and right upper caps.
Zigzag over raw edges of left stem, omitting edges that butt against right upper and lower caps.
Zigzag over outer raw edges of right stem.

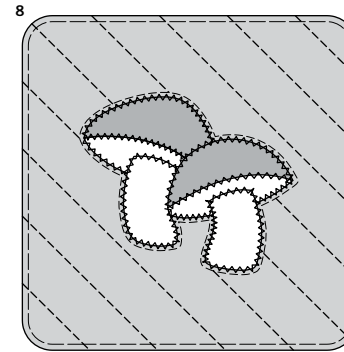

8. Zigzag over remaining raw edges of mushroom.

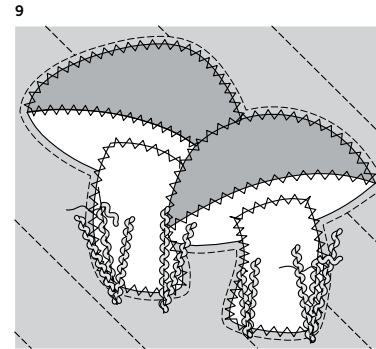

9. Make grass, as follows:
Center and pin rick rack over line in center of "V" on outer edges of stems; stitch along center of trim.
Center and pin trim over solid lines forming "Vs", flipping up trim at point; stitch along center of trim, pivoting with needle in fabric at point.

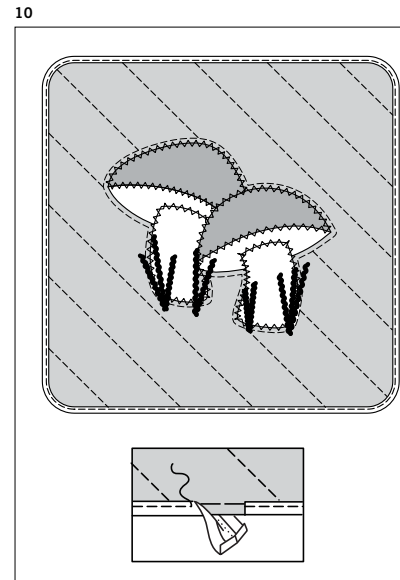

10. Slip raw edges of hot pad between folds of double fold bias tape, placing the raw edges against the center crease and the wider folded edge of the tape on the **INSIDE**, turning under ends on one long edge. Stitch tape in place from **OUTSIDE**, being sure to catch in folded edge on the **INSIDE**. See **GENERAL DIRECTIONS FOR DOUBLE FOLD BIAS TAPE**.



Congrats!

You've completed your sewing adventure

**SHARE
YOUR** LOOK



Post your pattern and tag us
@simplicity_creative_group and **#simplicitypatterns**
for a chance to be featured on our social media.

Look for more PDF patterns at [simplicity.com](https://www.simplicity.com)

Have a question or need help with your sewing project call us at
1-888-588-2700



Simplicity ©2023 a division of IG Design Group Americas Inc. • Atlanta, GA 30342 USA www.thedesigngroup.com • All Rights Reserved. www.simplicity.com • Made in the U.S.A. Fabriqué aux États-Unis.

To be used for individual private home use only and not for commercial or manufacturing purposes. • A usage privé seulement et non à des fins commerciales ou de production en série. • Para uso privado solamente, no se puede utilizar con propósitos de comercialización o de producción en serie.