

S9871

Simplicity[®]



easy-to-sew

Designed and printed in USA

Shop all the pattern brands you love @

Simplicity[®].com

Easy

KNIT HATS AND ARM WARMERS

Suggested Fabrics: Double Knits, Fleece, Jersey, Novelty Knit Fabrics, Sweater Knits, Velour. See Stretch Gauge. **Interfacing:** Lightweight Fusible.

Notions: D: Assorted Charms (optional).

Hat A - available in S,M,L

60** - ¾ yd. (150cm* - 0.4m)

Contrast (Band): 60** - ¾ yd. (150cm* - 0.4m)

Hat B - available in S,M,L

60** - ¾ yd. (150cm* - 0.4m)

Contrast (Band, Ties, Appliqués and Knots): 60** - ¾ yd. (150cm* - 0.6m)

Paper-Backed Fusible Web: 5" x 17" (13cm x 43cm) remnant

Hat C - available in S,M,L

60** - ¾ yd. (150cm* - 0.7m)

Interfacing: 20" - ¾ yd. (51cm* - 0.7m)

Hat D - available in S,M,L

60** - ¾ yd. (150cm* - 0.6m)

Arm Warmers E

60** - ½ yd. (150cm* - 0.5m)

*with nap **without nap



A



B

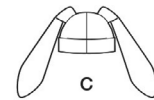

C



D

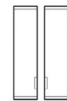

E

Use the 1 inch (2.54cm) box to ensure you are using rule at 100%

Utilisez la boîte de 2,54 cm pour vous assurer d'utiliser la règle à 100%.

Utilizar un cuadrado de 2.54 cm para asegurarse de estar usando la regla al 100%.

PICK-A-KNIT[®] RULE

FOR THIS PATTERN - 4" (10 cm) OF KNIT FABRIC MUST STRETCH CROSSWISE FROM HERE
POUR CE PATRON - LE JERSEY DOIT S'ETIRER DANS LA LARGEUR DE 4" (10 cm) DEPUIS ICI
PARA ESTE PATRON - LAS MALLAS DEBEN ESTIRARSE A LO ANCHO POR 4" (10 cm) DESDE AQUI

TO HERE 35%
JUSQUE LA 35%
HASTA ALLA 35%

When using the Pick-A-Knit[®] rule to measure your fabrics stretch capacity, rule must be viewed or printed at 100%.
Quand vous utilisez la règle Pick-A-Knit[®] pour mesurer la capacité d'élasticité des tissus, la règle doit être visible ou imprimée à 100%.
Al utilizar la regla Pick-A-Knit[®] para medir la capacidad de elasticidad de las telas, la regla debe estar visible o impresa al 100%.

Simplicity® S9871

Thank you for purchasing this Simplicity pattern.
We made every effort to provide you with a high quality product.

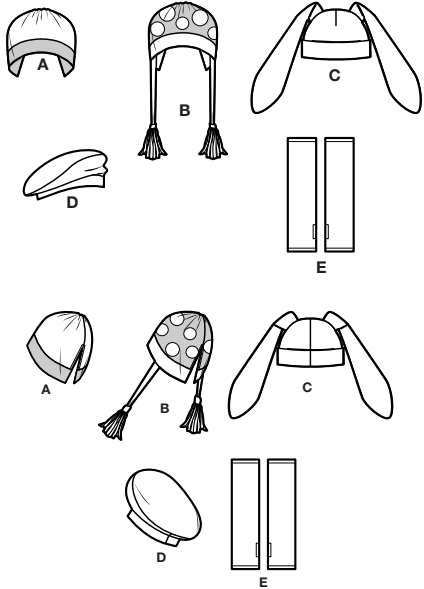

11 PIECES

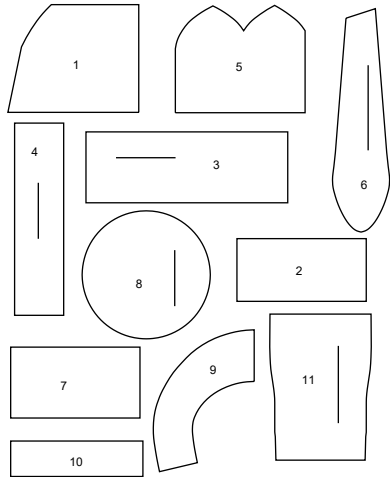

- 1 HAT - A,B
- 2 BAND - A,B
- 3 APPLIQUES AND KNOTS - B
- 4 TIES - B
- 5 HAT - C
- 6 EAR - C
- 7 BAND - C
- 8 TOP - D
- 9 CROWN - D
- 10 BAND - D
- 11 ARM WARMERS - E

Cutting Layouts

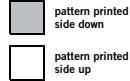

POSITION OF PATTERN PIECES MAY VARY
SLIGHTLY ACCORDING TO YOUR PATTERN SIZE

General Directions For Cutting

PRE-SHRINK and iron all fabric.

FOR DOUBLE THICKNESS -Fold fabric with RIGHT sides together.
Pin pattern to WRONG side of fabric.

FOR SINGLE THICKNESS -Pin pattern to RIGHT side of fabric.

★ If layout shows a piece extending past fold, cut out all pieces except piece that extends. Open out fabric to single thickness. Cut extending piece on RIGHT side of fabric in position shown.

✳ Mark small arrows along both selvages in dicated direction of nap or design. Fold fabric crosswise with RIGHT sides together, and cut along fold. Turn one fabric layer around so arrows on both layers go in the same direction. Place RIGHT sides together.

KNIT HATS AND ARM WARMERS AVAILABLE IN S,M,L
ALL VIEWS CUT OF STRETCH KNITS ONLY

HAT A PIECE 1

60" (150CM)
WITH NAP
ALL SIZES

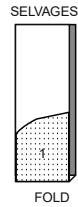

CONTRAST (BAND) PIECE 2

60" (150CM)
WITH NAP
ALL SIZES

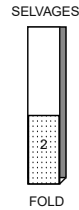

HAT B PIECE 1

60" (150CM)
WITH NAP
ALL SIZES

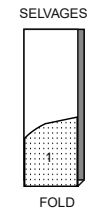

CONTRAST (BAND, TIES, APPLIQUE AND KNOTS) PIECES 2 3 4

60" (150CM)
WITH NAP
ALL SIZES

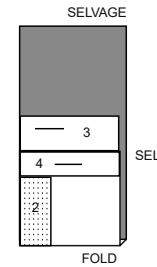

APPLIQUE AND KNOTS

CUT ONE 5" X 17" (13CM X 43CM) PIECE OF PAPER
BACKED FUSIBLE WEB

HAT C PIECES 5 6 7

60" (150CM)
WITH NAP
ALL SIZES

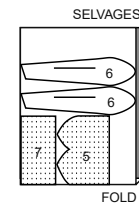

INTERFACING PIECE 6

20" (51CM)
ALL SIZES

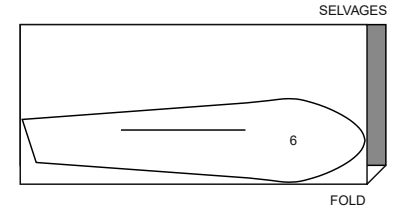

HAT D PIECES 8 9 10

60" (150CM)
WITH NAP
ALL SIZES

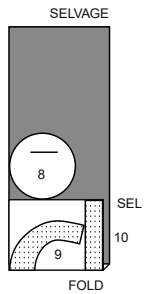

ARM WARMERS E PIECE 11

60" (150CM)
WITH NAP
ALL SIZES

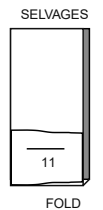

Sewing Directions

FABRIC KEY RIGHT SIDE WRONG SIDE INTERFACING LINING LINING

Read **General Directions** on page 1 before you begin.

Sewing methods in **BOLD TYPE** have Sewing Tutorial Video available. Scan QR CODE to watch videos:

EASE/GATHER - see Gathering: "sewing two row gathers" video.

STAYSTITCH - see Machine Stitches: "how to do stay-stitching" video.

PATTERN PIECES WILL BE IDENTIFIED BY NUMBERS THE FIRST TIME THEY ARE USED.

STITCH SEAMS WITH RIGHT SIDES TOGETHER UNLESS OTHERWISE STATED.

FOR KNITS

- Use a ball point or stretch needle.
- Decrease pressure on presser foot for heavy sweater knits; increase pressure for lingerie knits.
- Stretch knits need seams that are supple enough to "give" with the fabric. You can sew them with straight stitches (stretching the fabric slightly as you sew), narrow zigzag stitches or one of the stretch stitches built into many conventional machines, or on your serger.
- Some knits require very little or no pressing while sewing. Use the appropriate temperature setting. Press lightly or use steam.
- Use a twin sewing machine needle for a double stitched hem.

HAT A, B

HAT

- 1. GATHER** upper edge of Hat (1) between small dots.
- 2. Pull up** gathers to measure 5" (12.5cm). Fasten threads.
- 3. With right sides together**, pin hat, matching double notches, small and large dots. Stitch center back seam above large dot.
- 4. Stitch hat over** gathering stitches at upper edge.

SEWING TUTORIALS



Build your skills viewing short, easy-to-follow videos at [simplicity.com/sewingtutorials](https://www.simplicity.com/sewingtutorials)

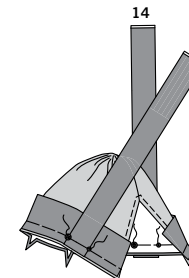
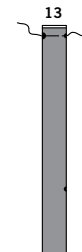
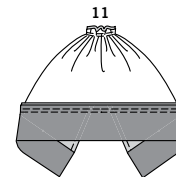
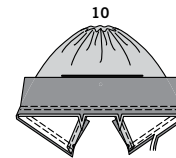
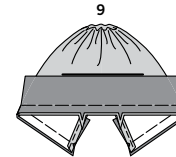
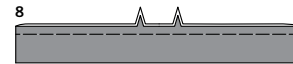
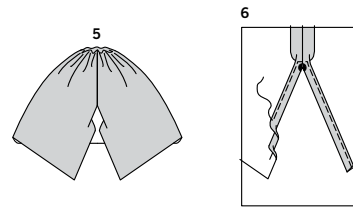
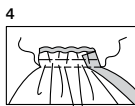
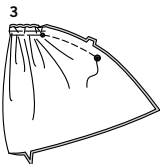
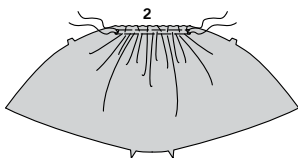
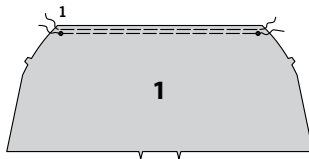

- 5. Turn hat right side out.**
- 6. Press up 5/8" (1.5cm) hem** on back opening edges below large dot.
To form narrow hem, tuck under raw edge to meet crease; press. Stitch hem in place, squaring stitching above large dot.

BAND

- 7. With right sides together**, fold Band (2) in half lengthwise, matching center fronts and dots. Stitch short ends; trim seams.

- 8. Turn right side out.** Baste raw edges together.

- 9. On outside**, pin band to lower edge of hat, matching dots and center fronts. Baste.

VIEW A

- 10. Stitch band along seam line.** Stitch again 1/4" (6mm) from first stitching within seam allowance. Trim close to second stitching.

- 11. Press seams toward hat**, pressing band down.

TIES B

- 12. With right sides together**, fold Ties (4) in half lengthwise, matching dots. Stitch long edge in a 3/8" (1cm) seam.
- 13. Turn right side out**, matching small dots. Baste end with dots.
- 14. On outside**, pin ties to hat (over band), matching small and large dots, having raw edges even. Baste.

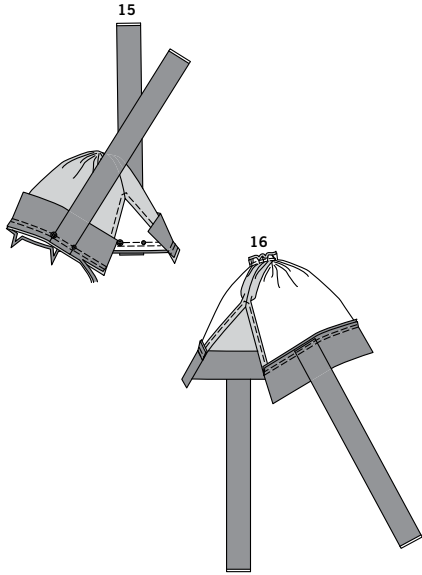

15. Stitch along seam line. Stitch again 1/4" (6mm) from first stitching within seam allowance. Trim close to second stitching.

16. Press seams toward hat, pressing band and ties down.

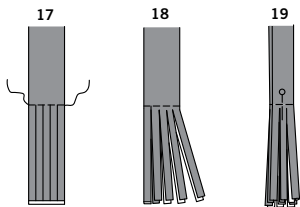

FINISHING B

17. For fringe, stitch lower edge of each tie section along stitching line.

18. Slash each fringe section along slash line, through all layers, from lower edge to 1/4" (6mm) below stitching line.

19. Loosely, roll fringe from one long edge to the other long edge along stitching line; pin.

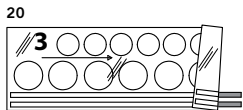

20. For knots, cut away long strip sections from Appliques and Knots (3) along long solid lines. (Save appliques section.)

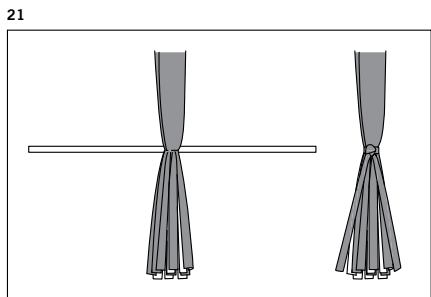

21. Wrap center of knot around fringe, covering stitching line. Tie in a knot, leaving ends hanging free over fringe, as shown.

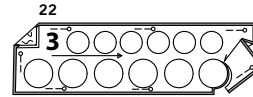

22.A. Apply paper backed fusible web to WRONG side of dot appliques fabric, following manufacturer's directions.

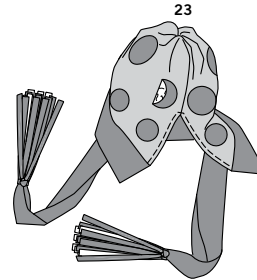

23. Cut applique tissue block along outer solid dot lines. Pin pattern to RIGHT side of prepared fabric. Cut out each dot applique.

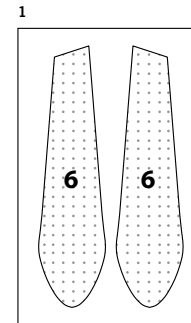

24. On outside, pin dot appliques to hat as desired. Be sure to clear all seam allowances and hems. A glue stick can be used to temporarily hold the appliques in place before stitching. Fuse appliques in place, following manufacturer's directions.

Stitch close to outer edges of appliques.

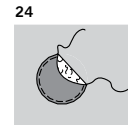

HAT C

EARS AND HAT

1. Apply fusible interfacing to WRONG side of two Ear (6) sections, following manufacturer's directions. (Uninterfaced ear sections will be used as facing.)

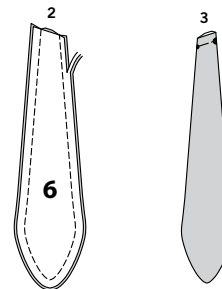

2. With right sides together, pin ear Facing (6) to ear, matching dots. Stitch, leaving short end free; trim seam.

3. Turn right side out. Baste raw edges together.

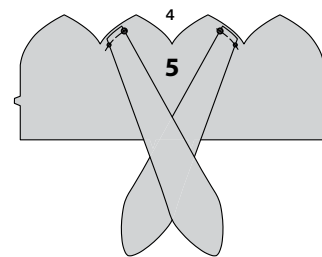

4. On outside, pin ears to Hat (5), matching dots and having raw edges even; baste.

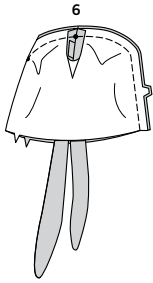
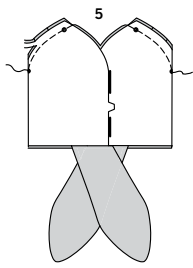

5. To make side darts (with ears), fold hat, right sides together, matching broken lines and small dots. Stitch along broken lines to lower small dot. Trim dart seam to 3/8" (1cm) from stitching. Press dart seam open.

6. Pin center back seam and center front in hat, right sides together, matching dots and seams. Stitch center back seam to lower small dot in center front. Trim seam to 3/8" (1cm) from stitching. Press seam open.

BAND

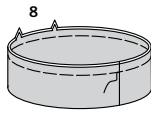
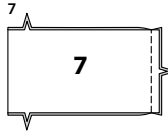

7. Stitch center back seam of Band (7).

8. Fold band in half lengthwise, wrong sides together, matching centers. Baste raw edges together.

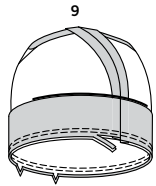

9. Pin band to wrong side of hat at lower edge, matching notches and centers. Stitch; trim seams.

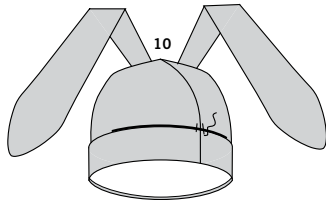

10. Turn band to outside on seam and tack to hat at center back seam.

HAT D

CROWN

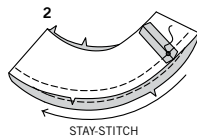
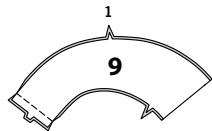

1. Stitch center back seam of Crown (9); press seam open.

2. STAYSTITCH upper edge of crown.

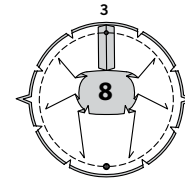

3. With right sides together, pin Top (8) to crown, matching notches, centers and dots, clipping crown where necessary. Stitch outer edge; trim seam. Press seam toward top.

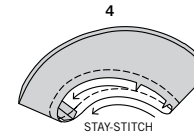

4. Turn right side out; press.

STAYSTITCH lower edge of crown.

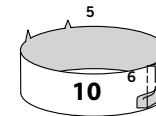

BAND

5. Stitch center back seam of Band (10).

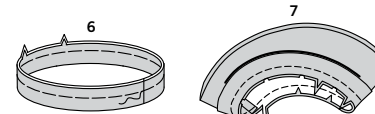

6. Fold band in half lengthwise, wrong sides together, matching centers. Baste raw edges together.

7. With right sides together, pin band to crown, matching notches and centers, clipping crown where necessary. Stitch; trim seams.

8. Press seam toward crown, turning band out.

OPTIONAL: Apply purchased assorted charms to band as desired, following manufacturer's directions.

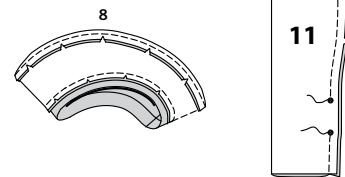

ARM WARMERS E

1. With right sides together, pin Arm Warmers (11) in half lengthwise, matching, notches and dots. Stitch notched edge, leaving free between dots.

2. Press under 5/8" (1.5cm) on opening edges between dots.

To form narrow hem, tuck under raw edge to meet crease; press.

3. Stitch hem close to inner pressed edge, squaring stitching above and below dots.

4. Press up a 5/8" (1.5cm) hem on upper and lower edges of arm warmer.

To form narrow hem, tuck under raw edge to meet crease; press.

Stitch hem in place.

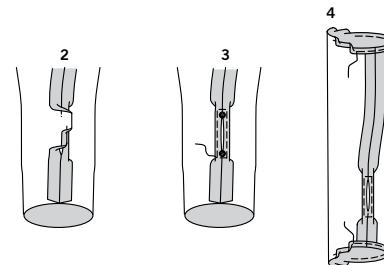



Congrats!

You've completed your sewing adventure

**SHARE
YOUR** LOOK



Post your pattern and tag us
@simplicity_creative_group and **#simplicitypatterns**
for a chance to be featured on our social media.

Look for more PDF patterns at [simplicity.com](https://www.simplicity.com)

Have a question or need help with your sewing project call us at
1-888-588-2700



Simplicity ©2023 a division of IG Design Group Americas Inc. • Atlanta, GA 30342 USA www.thedesigngroup.com • All Rights Reserved. www.simplicity.com • Made in the U.S.A. Fabriqué aux États-Unis.

To be used for individual private home use only and not for commercial or manufacturing purposes. • A usage privé seulement et non à des fins commerciales ou de production en série. • Para uso privado solamente, no se puede utilizar con propósitos de comercialización o de producción en serie.