

S9834

**Simplicity**



Shop all the pattern brands you love @

**Simplicity.com**

Average

**MISSES' HATS IN FIVE STYLES**

**Suggested Fabrics:** A,B,D,E: Felt. C: Silk Taffeta. **Contrast B:** Netting, Lace and Tulle.  
**Interfacing A,D,E:** Fusible.

**Notions:**

**Hat A:** 3 yds. (2.7m) of 1 3/8" (35mm) grosgrain ribbon, 3/4 yd. (0.7m) of 3/8" (22mm) grosgrain ribbon, 3/4 yd. (0.4m) of elastic cord, one skein of perle cotton, 3" (75mm) hat pin, one 10" (26cm) styrofoam wreath and terry wash cloth.

**Hat B:** 3/4 yd. (0.6m) of 1" (25mm) grosgrain ribbon, 3/4 yd. (0.4m) of elastic cord, 3/4 yd. (0.7m) of 18 gauge (1.2mm) wire, one 10" x 10" (26cm x 26cm) buckram remnant, 3" (75mm) hat pin, one 6" (15cm) styrofoam ball and terry wash cloth.

**Hat C:** 3/4 yd. (0.8m) of 2" (50mm) ribbon, 3/4 yd. (0.2m) of elastic cord, 1 yd. (1.0m) of 18 gauge (1.2mm) wire, 3" (75mm) hat pin, craft glue, one 6" (15cm) styrofoam ball and terry wash cloth.

**Hat D,E:** 3/4 yd. (0.7m) of 1" (25mm) grosgrain ribbon and 1/4 yd. (0.2m) of 1/4" (6mm) elastic.

**Also for E:** 1 yd. (1.0m) of 2" (5mm) ribbon, 3/4 yd. (0.4m) of 1/2" (13mm) cord, 5mm glue-on jewels and jewel glue.

**Hat A**

72"\* - 3/4 yd. (180cm - 0.6m)

**Interfacing:** 20" - 3/4 yd. (51cm - 0.7m)

**Paper-backed fusible web:** 17" - 3/4 yd. (43cm - 0.6m)

**Hat B**

72"\* - 3/4 yd. (180cm - 0.6m)

**Contrast (Side):** 7" x 7" (18cm x 18cm) remnant

**Hat C**

45, 60"\* - 1 yd. (115, 150cm\* - 0.9m)

**Buckram:** 20" - 3/4 yd. (51cm - 0.6m)

**Hat D**

72"\* - 3/4 yd. (180cm - 0.7m)

**Interfacing D,E:** 20" - 3/4 yd. (51cm - 0.7m)

**Hat E**

72"\* - 3/4 yd. (180cm - 0.7m)

\*with nap \*\*without nap

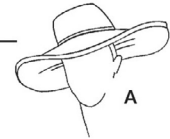

A



B

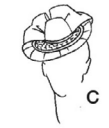

C



D



E

# Simplicity® S9834

Thank you for purchasing this Simplicity pattern.  
We made every effort to provide you with a high quality product.

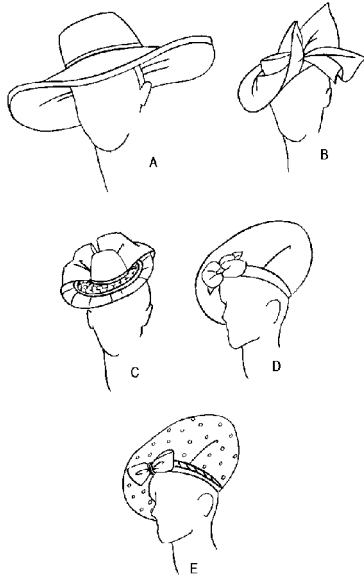

## Cutting Layouts

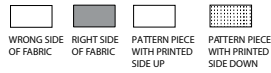

POSITION OF PATTERN PIECES MAY VARY SLIGHTLY ACCORDING TO YOUR PATTERN SIZE

### General Directions For Cutting

PRE-SHRINK and iron all fabric.

**FOR DOUBLE THICKNESS** -Fold fabric with RIGHT sides together. Pin pattern to WRONG side of fabric.

**FOR SINGLE THICKNESS** -Pin pattern to RIGHT side of fabric.

★ If layout shows a piece extending past fold, cut out all pieces except piece that extends. Open out fabric to single thickness. Cut extending piece on RIGHT side of fabric in position shown.

\* Mark small arrows along both selvages indicating direction of nap or design. Fold fabric crosswise with RIGHT sides together, and cut along fold. Turn one fabric layer around so arrows on both layers go in the same direction. Place RIGHT sides together.

### HAT A

USE PIECES 1 2 3

72" (180CM)  
WITH NAP  
ONE SIZE

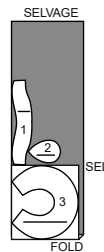

### HAT B

USE PIECES 5 6 7

72" (180CM)  
WITH NAP  
ONE SIZE

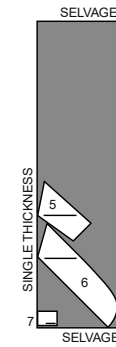

### HAT D

USE PIECES 15 16 17 18

72" (180CM)  
WITH NAP  
ONE SIZE

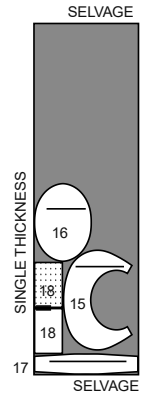

### FUSIBLE INTERFACING A

USE PIECES 1 2

20" (51CM)  
ONE SIZE



### CONTRAST B

USE PIECE 6

7" (18CM) REMMANT  
WITH NAP  
ONE SIZE

### HAT C

USE PIECES 9 10 11 12 14

45" TO 60"  
(115CM TO 160CM)  
WITH NAP  
ONE SIZE

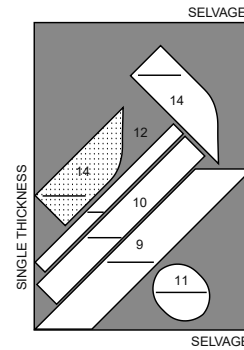

### HAT E

USE PIECES 15 16 17

72" (180CM)  
WITH NAP  
ONE SIZE

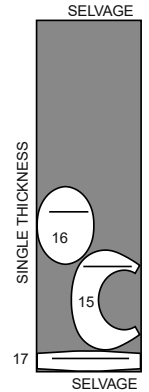

### BUCKRAM C

USE PIECES 8 11 13

20" (51CM)  
WITH NAP  
ONE SIZE

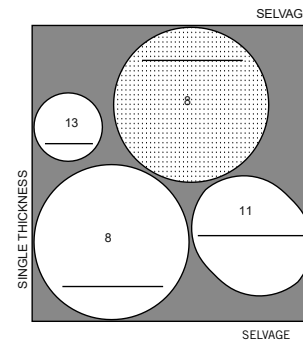

### FUSIBLE INTERFACING D,E

USE PIECE 17

20" (51CM)  
ONE SIZE



18 PIECES

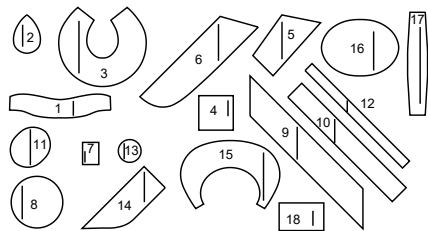

- 1 Crown-A
- 2 Top-A
- 3 Brim-A
- 4 Side-B
- 5 Back-B
- 6 Front-B
- 7 Knot-B
- 8 Brim-C
- 9 Bias-C
- 10 Bias-C
- 11 Crown-C
- 12 Bias-C
- 13 Stay-C
- 14 Bow-C
- 15 Crown-D,E
- 16 Top-D,E
- 17 Band-D,E
- 18 Flower-D

### PAPER BACKED FUSIBLE WEBBING A

USE PIECE 3

17" (43CM)  
WITH NAP  
ONE SIZE

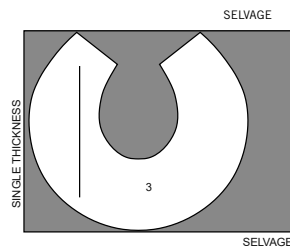

SEWING TUTORIALS



Build your skills viewing short, easy-to-follow videos at [simplicity.com/sewingtutorials](http://simplicity.com/sewingtutorials)

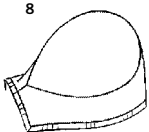
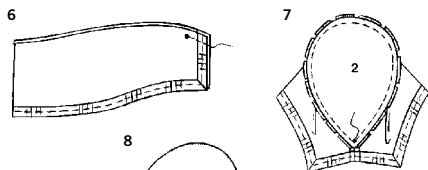
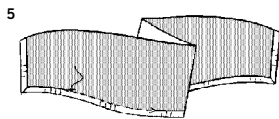
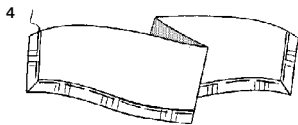
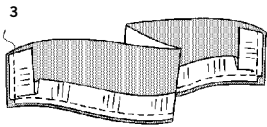
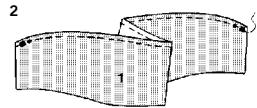
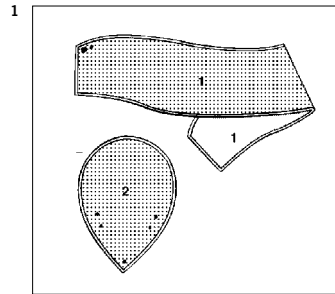

## Sewing Directions

FABRIC KEY RIGHTSIDE WRONGSIDE INTERFACING LINING LINING

Read **General Directions** on page 1 before you begin.

Sewing terms appearing in **BOLD TYPE** in Sewing Instructions are explained below.

**EDGESTITCH** - See [edgestitch](#) video.

**GATHER** - See [gather](#) video.

**NARROW HEM** - See [narrow hem](#) video.

**SLIPSTITCH** - see [slipstitch](#) video.

## HAT A

1. Fuse INTERFACING to wrong side of each matching FABRIC section, following manufacturer's instructions.  
**Note:** Interfacing will not be shown in the following illustrations.

2. To stay upper edge of CROWN (1), stitch 1/4" (6mm) from edge.

3. Pin 1 3/8" (3.5cm) ribbon along sides and lower edges of crown, having edges even and clipping at corners. Stitch in a 1/4" (6mm) seam. Do not trim seam.

4. Turn ribbon to inside over seam, folding in fullness at corners; press. Baste in place.

5. On outside, spread seam with fingers until stitching is visible. Stitch on top of previous stitching.

6. Stitch upper edges of crown together below small circle, as shown.

7. Pin TOP (2) to crown, matching small circles and clipping crown where necessary. Stitch, breaking stitching at small circle.

8. Turn right side out; press.

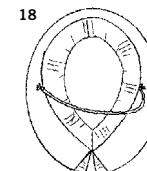
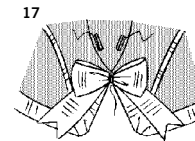
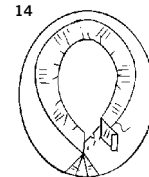
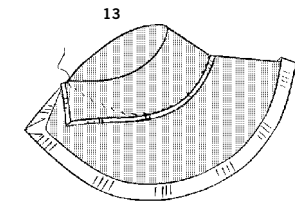
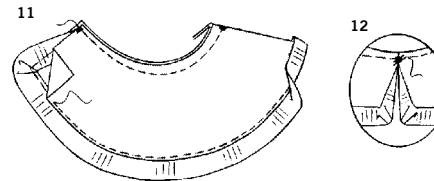
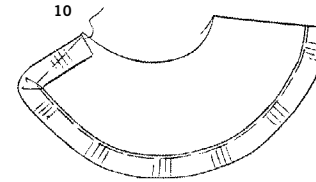
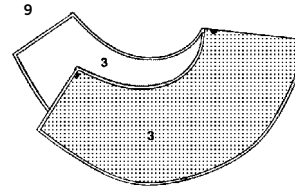

9. Fuse WEBBING to wrong side of one BRIM (3) section, following manufacturer's instructions.

10. On wrong side, place one long edge of 1 3/8" (3.5cm) ribbon slightly over outer edges of remaining brim section, folding fullness at corners into a pleat and tapering ends at square, as shown. Baste in place.

11. Fuse brim sections together. Stitch along stitching line. **EDGESTITCH** along outer edges of brim. Press ribbon up.

12. Tack brim together at squares.

13. Place seamline and stitching on crown along stitching line on brim, matching symbols. Sew in place along stitching lines.

14. On inside, clip inner curved edge of brim to stitching. Place 7/8" (2.2cm) ribbon slightly over stitching, turning in one end and lapping over remaining end at square. Sew lower edge and end in place. Press ribbon toward crown.

15. Cut one section from 1 3/8" (3.5cm) ribbon, 19" (49cm) long. To make bow, fold ribbon in half crosswise. Stitch across ribbon 10" (25cm) from folded end.

16. Center folded end of ribbon over seam. Wrap thread tightly around center; secure thread ends. Trim ends, as shown.

17. Tack bow to back at square. Tack top and brim together, making long straight stitches between small circles, as shown, using perle cotton.

18. Cut one piece of elastic cord, 12" (31cm) long. On inside, tack ends of elastic to sides of hat. To shape ribbon on outer edge, cut a 3" (7.5cm) section from styrofoam wreath. Place wash cloth over styrofoam. Steam ribbon over covered styrofoam.

## HAT B

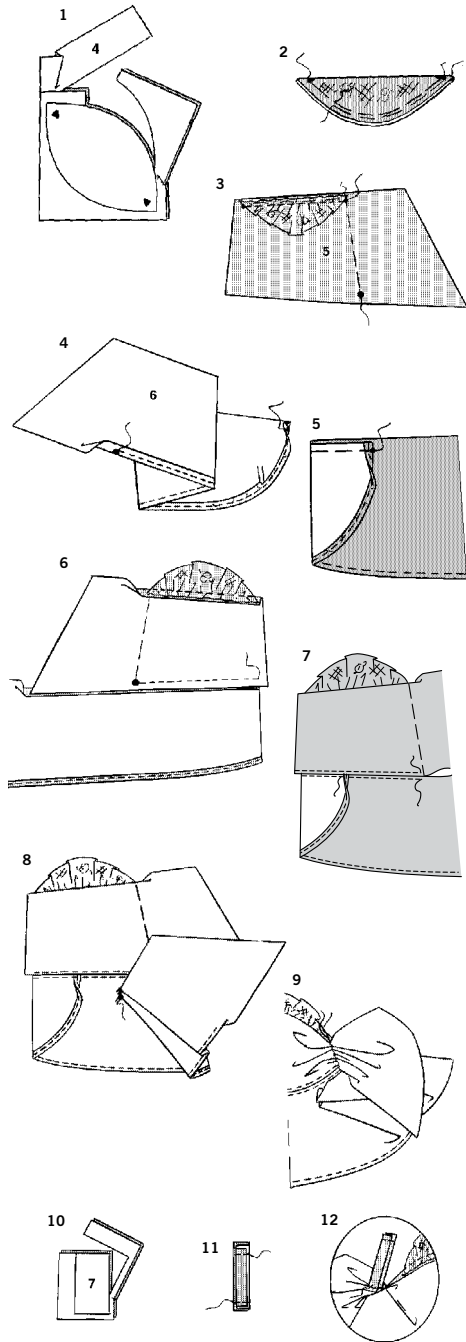

1. Pin pattern tissue for SIDE (4) over contrast remnant, having sides and lower edges even. Cut outside. Transfer markings.
2. With wrong sides together, fold side along roll line; press lightly. Baste raw edges together.  
**GATHER** curved edge of side.
3. Pin side to side edge of BACK (5), matching small circles. Adjust gathers; baste. Stitch. Press seam toward back. Hand gather along stitching line.
4. To form casing, turn in seam allowance on outer edge of FRONT (6) below large circle, easing in fullness; press. Stitch 1/4" (6mm) from pressed edge, ending at large circle. Trim close to stitching. Insert wire into casing, having ends of wire 1/2" (1.3cm) from ends of casing. Turn lower end to outside at small circle, as shown. Baste.
5. Bring lower end of front up, matching small circles. Baste raw edges together.
6. Pin back and front together, matching large circles. Stitch, leaving open above large circle.
7. **EDGE STITCH** back and front long seam, breaking stitching at folded end on front.
8. Fold front, as shown, matching squares. Tack at squares.
9. Adjust gathers on back tightly; secure thread ends.
10. Cut out KNOT (7).
11. Fold Knot 7 into thirds, as shown. Baste along upper and lower edges.
12. On inside, place one end of knot slightly over gathers. Sew in place.

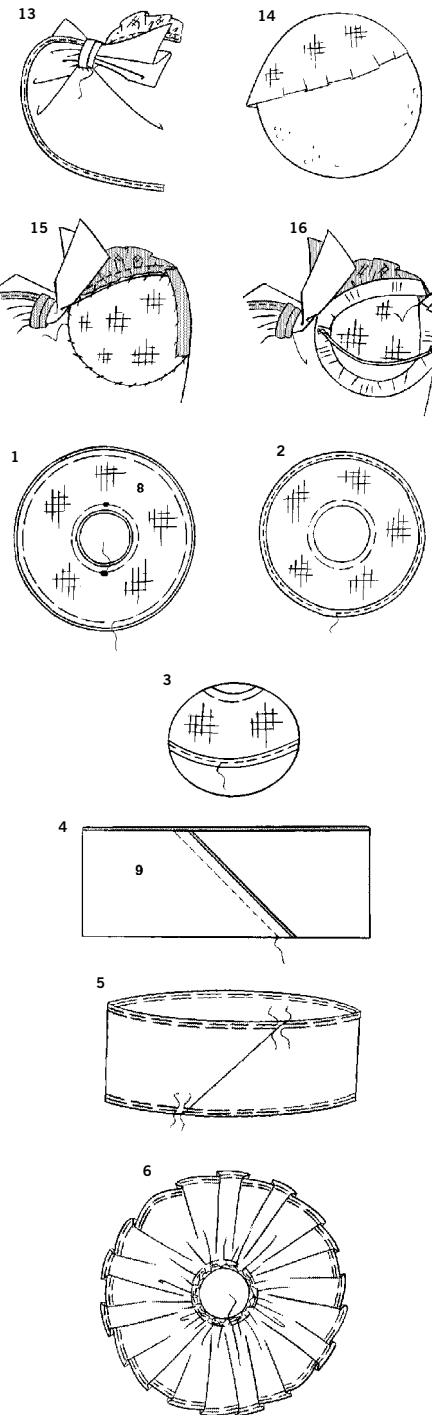

13. Wrap knot around upper end of front, as shown. Sew remaining end of knot in place.
14. Place a damp wash cloth over styrofoam ball. Steam buckram remnant over ball. Trim buckram evenly around ball, leaving a point at one corner.
15. Open out seam allowance on side edge of back. Place buckram inside hat. Turn seam allowance on side and lower edge of back to inside; press. Sew in place.
16. Place one long edge of ribbon along edges of front, back and over edges of buckram cap, turning under one end and lapping over remaining end. Sew in place. Cut one piece of elastic cord, 12" (31cm) long. On inside, tack ends of elastic to sides of hat.

## HAT C

1. Cut out opening in center of each BRIM (8) section. Pin brim sections together, having edges even; baste.
2. Turn in 1/4" (6mm) on outer edge of brim, easing in fullness; press. Stitch 1/8" (3mm) from pressed edge, leaving a small opening for wire.
3. Insert wire into opening. Trim ends of wire to meet. Stitch remainder of opening.
4. Stitch ends of BIAS (9) together.
5. To **GATHER** upper and lower edges of bias, stitch 1/4" (6mm) from edge, using long machine stitches. Stitch again 1/8" (3mm) away.
6. Pin one long edge of bias along inner curved edge of brim, having raw edges even. Adjust gathers; baste.

7

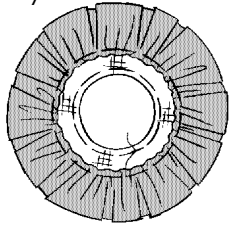

7. Turn bias to outside, placing remaining edge along placement line. Adjust gathers; baste.

8

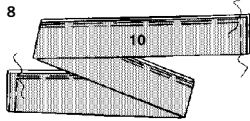

8. With wrong sides together, fold BIAS (10) along roll line; press. Baste raw edges together. To gather upper edge of bias, stitch 1/4" (6mm) from raw edge, using long machine stitches. Stitch again 1/8" (3mm) away.

9

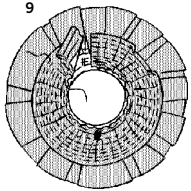

9. On outside, place pressed edge of bias 1 1/4" (3.2cm) from outer edge of brim, having raw edge even with inner curved edge, turning in one end and lapping over remaining end at small circle. Adjust gathers; baste. Stitch 1/4" (6mm) from pressed edge. Make six additional rows of stitching 1/4" (6mm) apart, as shown. Lightly press edge of bias 10 toward inside.

10

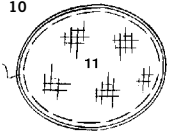

11

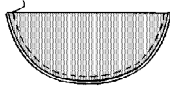

10. Pin BUCKRAM (11) to wrong side of CROWN (11); baste.

11. With wrong sides together, fold crown along roll line; press. Baste raw edges together. Stitch close to outer curved edge.

12



13

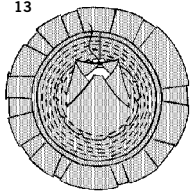

12. Tack ends together at small circles.

13. Pin crown to brim, placing lower edge along seamline, matching symbols, and clipping crown where necessary. Stitch close to lower edge of crown.

14

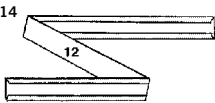

15

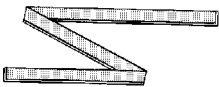

14. Turn in 3/8" (1cm) on long edges on BIAS (12); press.

15. With wrong sides together, fold bias along roll line, having pressed edges even. Press.

16. Place pressed edges of bias onto brim, 1/8" (3mm) from lower edge of crown, turning in one end and lapping over remaining end at back. Sew lower edges of bias in place, stretching slightly to shape. **SLIPSTITCH** ends. **Note:** Remainder of bias will be used later.

16

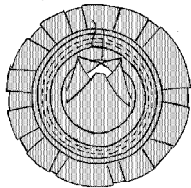

17

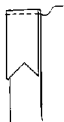

18



17. Cut two pieces of ribbon, each 13 1/2" (34cm) long. Turn in 4" (10cm) on one end of each ribbon; press. To form casing for elastic, stitch 1/4" (6mm) from pressed edge. Trim end, as shown.

18. Make a small pleat on remaining end of ribbon sections, as shown. Baste.

19

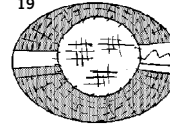

19. On inside, lap pleated end of ribbon 1/2" (1.3cm) over inner edge of brim at sides. Baste in place.

20

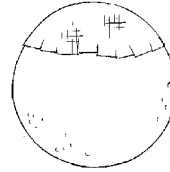

21

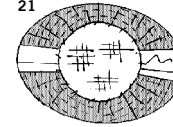

20. Place a damp wash cloth over styrofoam ball. Steam STAY (13) over ball, shaping sides.

21. Place stay inside hat. Sew edges of stay and brim together.

22

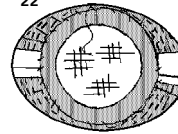

23

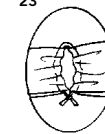

22. Pin remainder of bias 12 over edges of stay, turning in one end and lapping over remaining end. Sew outer pressed edge of bias in place. **SLIPSTITCH** ends. Glue inner edge of bias to stay.

23. Cut one piece of elastic cord, 3" (7.5cm) long. Insert elastic into each ribbon casing, as shown. Tie ends of elastic together.

24

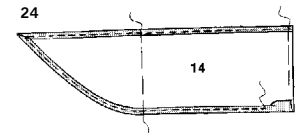

24. Make 1/2" (1.3cm) **NARROW HEM** along upper and lower edges of BOW (14), diagonally folding in fullness at corners. Hand gather 1/4" (6mm) from straight end of bow and along stitching line.

25

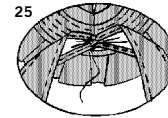

26

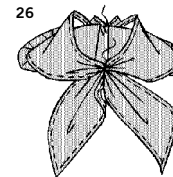

25. Adjust gathers on end of bow tightly; secure thread ends. Lap gathered ends 2" (5cm) from outer edge of brim at center back. Tack in place.

26. Turn back of brim up, as shown. Tack brim to upper front edge of crown. Adjust remaining gathers on bow tightly; secure thread ends. Tack gathers to underside of brim at center back, as shown.

## HAT D, E

**NOTE:** Illustrated for View D, unless otherwise indicated. Seam allowances are 1/4" (6mm).

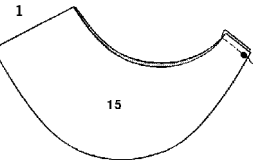

1. Stitch ends of CROWN (15) together.

2

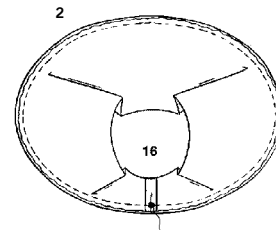

2. Pin TOP (16) to crown, matching large circles and having edges even. Stitch, easing in fullness.

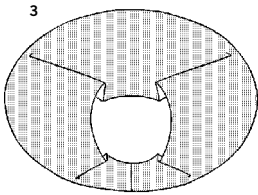

**3.** Turn right side out; press.

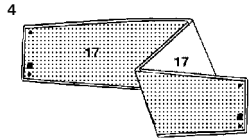

**4.** Fuse INTERFACING (17) to wrong side of BAND (17), following manufacturer's instructions.



**5.** Cut two pieces of elastic, each 2" (5cm) long. Center ends of elastic sections over squares on band, having raw edges even, as shown. Baste in place.

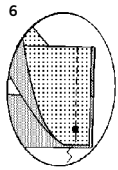

**6.** With right sides together, fold band along foldline. Stitch ends.

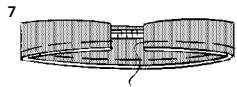

**7.** Turn right side out; press. Baste raw edges together.

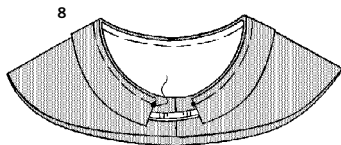

**8.** Pin band to lower edge of crown, matching small circles. Baste.

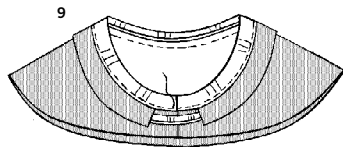

**9.** Pin 1" (2.5cm) grosgrain ribbon to brim, placing one long edge slightly over seamline and turning in one end and lapping over remaining end at seam. Stitch along seamline.

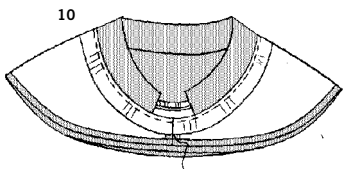

**10.** Press seam allowance and ribbon toward inside. Sew ends of ribbon together.

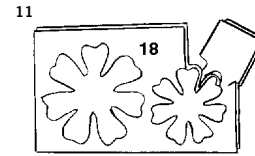

## VIEW D

**11.** Cut out FLOWER (18) sections.

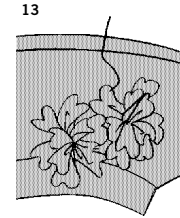
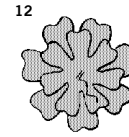

**12.** Center small flower over large flower. Tack in center.

**13.** To shape flower, make small pleats on underside of each flower, as shown. Sew in place. Arrange flowers on front of hat, as desired. Tack in place.

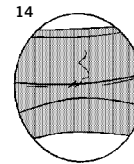

## VIEW E

**14.** To form pleat on front of crown, on outside, tack small circles together.

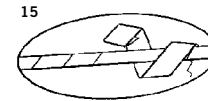

**15.** Cut one piece of cord, 12" (31cm) long. Wrap 2" (5cm) ribbon around cord, turning under 1/2" (1.3cm) on ends. Sew ends in place.

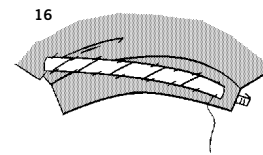

**16.** Tack one end of covered cord to front pleat and remaining end to back of band.



**17.** For bow, cut one section from remainder of 2" (5cm) ribbon, 15 1/2" (40cm) long. Lap ends of bow 1/2" (1.3cm) at center back; hand gather along center. Adjust gathers tightly; secure thread ends.

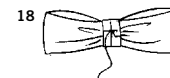

**18.** For knot, cut one section from 2" (5cm) ribbon, 4" (10cm) long. Form a small pleat in center of knot, as shown. Wrap knot around bow, turning in 1/2" (1.3cm) on one end and lapping over remaining end.

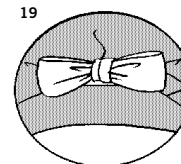

**19.** Center bow over front pleat; tack in place. Glue jewels to top and crown, as desired.



# Congrats!

You've completed your sewing adventure

---

**SHARE  
YOUR** LOOK



Post your pattern and tag us  
**@simplicity\_creative\_group** and **#simplicitypatterns**  
for a chance to be featured on our social media.

Look for more PDF patterns at **simplicity.com**

Have a question or need help with your sewing project call us at  
1-888-588-2700

**Simplicity**  
by design™

Simplicity ©2023 a division of IG Design Group Americas Inc. • Atlanta, GA 30342 USA www.thedesigngroup.com • All Rights Reserved. www.simplicity.com • Made in the U.S.A. Fabriqué aux États-Unis.

To be used for individual private home use only and not for commercial or manufacturing purposes. • A usage privé seulement et non à des fins commerciales ou de production en série. • Para uso privado solamente, no se puede utilizar con propósitos de comercialización o de producción en serie.